



Part no.: 50128786
DCR 202i FIX-M1-102-R3-G
Stationary 2D-code reader



RS232

RS422

Ethernet

Figure can vary

Contents

- Technical data
- Dimensioned drawings
- Electrical connection
- Diagrams
- Operation and display
- Accessories
- Notes



Technical data

Basic data	
Series	DCR 200i
Functions	
Software functions	Reading of 2D codes Reading of 1D codes
Read data	
Code types, readable	Code 128 PDF417 Codabar Code 39 EAN 8/13 Data Matrix Code UPC GS1 Databar Omnidirectional GS1 Databar GS1 Databar QR code QR code Pharma Code Code 93 Aztec Code 32 EAN 128 2/5 Interleaved GS1 Databar Stacked
Optical data	
Reading distance	50 ... 220 mm
Light source	LED, Red
Transmitted-signal shape	Pulsed
Camera resolution, horizontal	1,280 px
Camera resolution, vertical	960 px
Chip	CMOS
Module size	0.19 ... 0.5 mm
Electronic shutter speed	0.068 ... 5 ms
Camera type	Monochrome
Electrical data	
Protective circuit	Short circuit protected Polarity reversal protection
Performance data	
Supply voltage	18 ... 30 V, DC
Average power consumption	8 W
Inputs	
Number of digital switching inputs	1 Piece(s)
Switching inputs	
Type	Digital switching input
Voltage type	DC

Outputs

Number of digital switching outputs 1 Piece(s)

Switching outputs

Type Digital switching output

Voltage type DC

Switching current, max. 100 mA

Switching output 1

Switching element Transistor,

Switching principle +24 V switching

Inputs/outputs selectable

Number of inputs/outputs selectable 2 Piece(s)

Type Inputs/outputs selectable

Voltage type DC

Voltage type DC

Interface

Type RS 232, RS 422, Ethernet

RS 232

Function Process

Transmission speed 4,800 ... 115,200 Bd

Data format Adjustable

Start bit 1

Data bit 8 data bits

Stop bit 1 stop bit

Parity None

Transmission protocol <STX><data><CR><LF>

 Data encoding Binary
ASCII

RS 422

Function Process

Transmission speed 4,800 ... 115,200 Bd

Data format Adjustable

Start bit 1

Data bit 7, 8 data bits

Stop bit 1, 2 stop bits

Parity Adjustable

 Data encoding ASCII
Binary

Ethernet

 Architecture Client
Server

 Address assignment DHCP
Manual address assignment

 Transmission speed 100 Mbit/s
10 Mbit/s

Function Process

Switch functionality None

Transmission protocol TCP/IP , UDP

Service interface

Type Ethernet

Ethernet

Function	Service
----------	---------

Connection

Number of connections	2 Piece(s)
-----------------------	------------

Connection 1

Type of connection	Connector
Function	Signal IN Data interface Voltage supply Signal OUT
Thread size	M12
Type	Male
Material	Metal
No. of pins	12 -pin
Encoding	A-coded

Connection 2

Type of connection	Connector
Function	Configuration interface Data interface
Thread size	M12
Type	Female
Material	Metal
No. of pins	4 -pin
Encoding	D-coded

Mechanical data

Design	Cubic
Dimension (W x H x L)	43 mm x 61 mm x 44 mm
Housing material	Metal Plastic, Diecast aluminum, PC
Lens cover material	Glass
Net weight	120 g
Housing color	Silver
Type of fastening	Via optional mounting device Mounting thread

Operation and display

Type of display	LED
Number of LEDs	10 Piece(s)
Type of configuration	Teach-in Configuration codes Via web browser
Operational controls	Buttons
Function of the operational control	Auto-setup Adjustment mode Trigger

Environmental data

Ambient temperature, operation	0 ... 50 °C
Ambient temperature, storage	-20 ... 70 °C
Relative humidity (non-condensing)	90 %

Certifications	
Degree of protection	IP 65
Protection class	III
Certifications	c UL US
Test procedure for EMC in accordance with standard	EN 61000-6-4 EN 61000-6-2
Test procedure for continuous shock in accordance with standard	IEC 60068-2-29, test Eb
Test procedure for vibration in accordance with standard	IEC 60068-2-6, test Fc

Classification	
eCl@ss 8.0	27280103
eCl@ss 9.0	27280103
ETIM 5.0	EC002550

Dimensioned drawings

All dimensions in millimeters

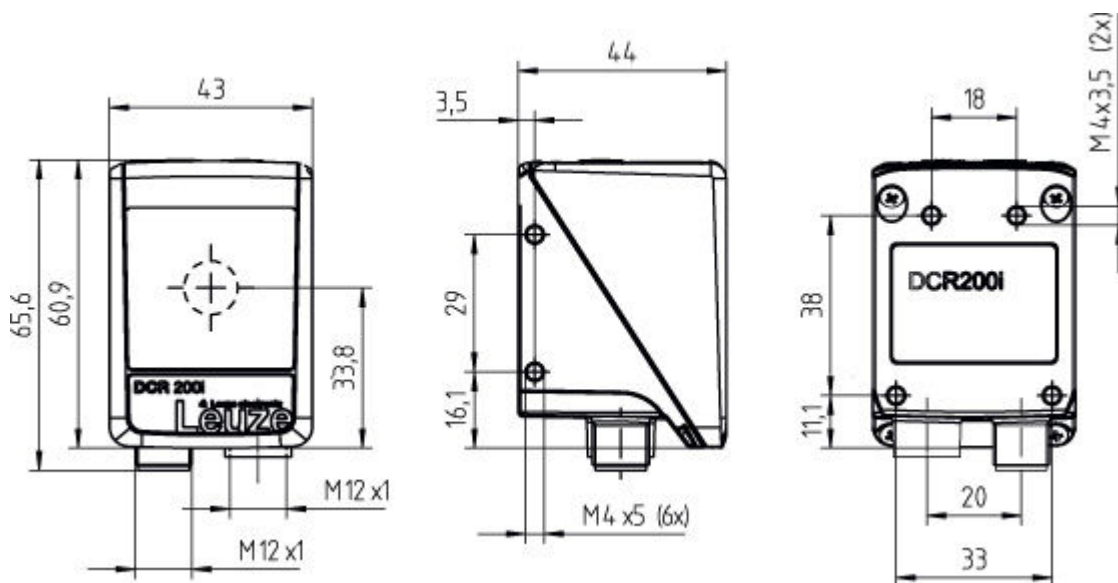

Electrical connection

Connection 1	PWR / SWIO
Type of connection	Connector
Function	Signal IN Data interface Voltage supply Signal OUT
Thread size	M12
Type	Male
Material	Metal
No. of pins	12 -pin
Encoding	A-coded

Part no.: 50128786 – DCR 202i FIX-M1-102-R3-G – Stationary 2D-code reader

Pin	Pin assignment
1	VIN
2	GNDIN
3	SWIN 1
4	SWOUT 2
5	FE
6	GND RS 232 / GND RS 422
7	Rx-
8	Tx-
9	RxD/Rx+
10	TxD/Tx+
11	SWIO 3
12	SWIO 4

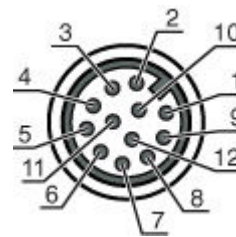

Connection 2	HOST
Type of connection	Connector
Function	Configuration interface Data interface
Thread size	M12
Type	Female
Material	Metal
No. of pins	4 -pin
Encoding	D-coded

Pin	Pin assignment
1	TD+
2	RD+
3	TD-
4	RD-

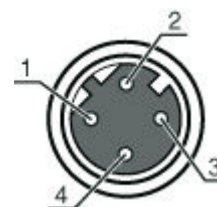

Diagrams

Reading distances

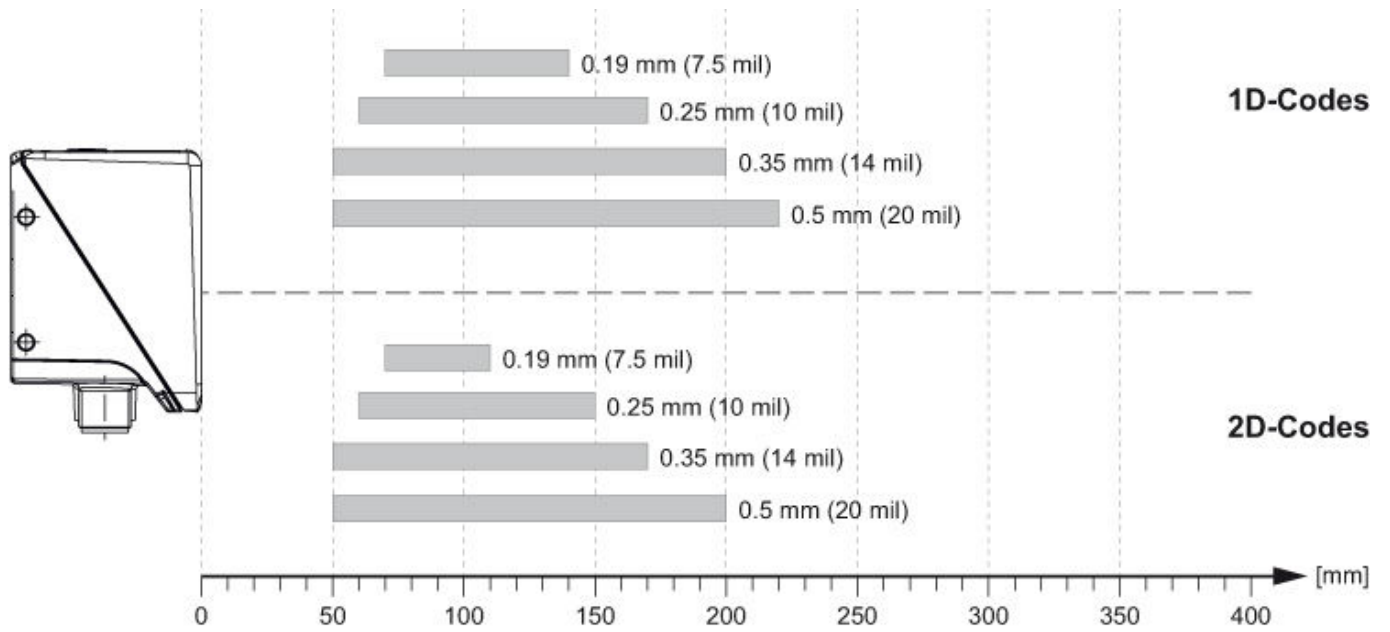

Relationship between camera distance and reading field size

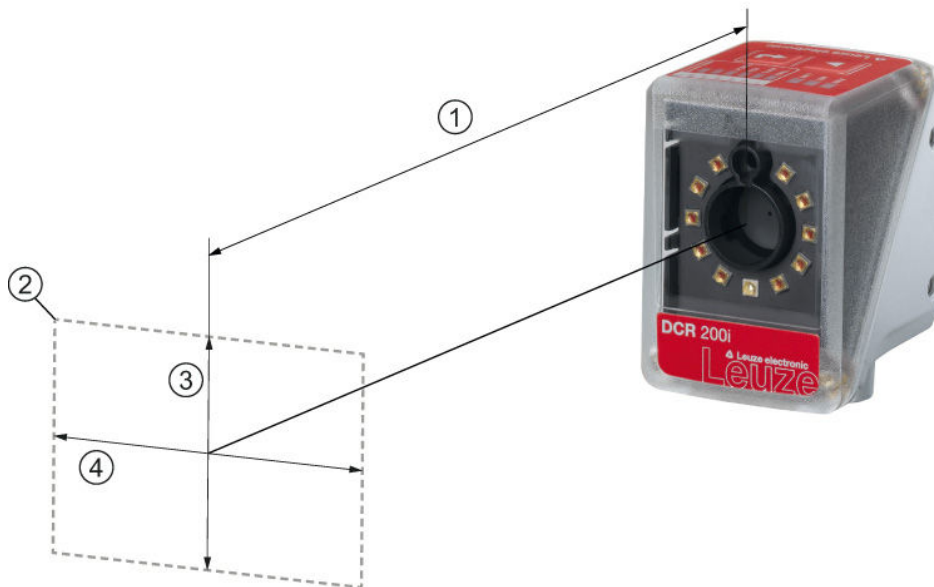

- 1 Camera distance
- 2 Reading field
- 3 Reading field height [mm]
- 4 Reading field width [mm]

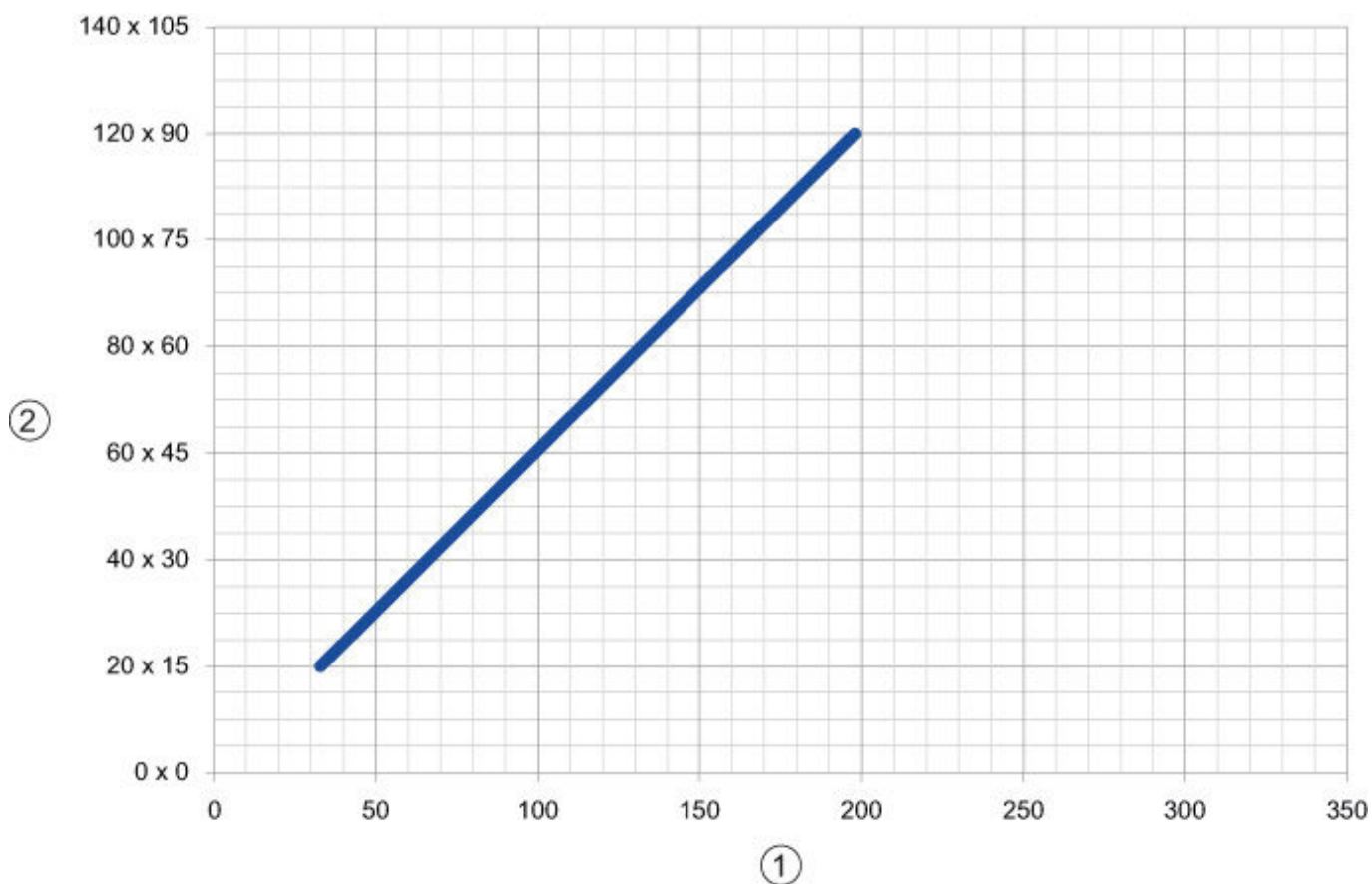

- 1 Camera distance [mm]
- 2 Reading field: width x height [mm]







Operation and display

LEDs

LED	Display	Meaning	
1	PWR	Off	No supply voltage
		Green, flashing	Initialization
		Green, continuous light	Operational readiness
		Orange, continuous light	Service operation
		Red, flashing	Device OK, warning set
		Red, continuous light	Device error
2	NET	Off	No supply voltage
		Green, flashing	Initialization
		Green, continuous light	Operational readiness
		Red, flashing	Communication error
		Red, continuous light	Network error
3	LINK	Green, continuous light	Ethernet connection is established
		Yellow, flashing	Data exchange active
4	TRIG	Green, flashing	Trigger and display of the read quality
5	AUTO	Green, flashing	Auto-setup and display of the read quality
6	ADJ	Green, flashing	Alignment mode and display of the read quality
7	TEACH	Green, flashing	Teach-in and display of the read quality

Accessories







Connection technology - Connection unit

	Part no.	Designation	Article	Description
	50130109	MA 150	Modular connection unit	Supply voltage: 18 ... 30 V Current consumption, max.: 150 mA Connections: 5 Piece(s) Degree of protection: IP 67
	50112893	MA 204i Profibus Gateway	Modular connection unit	Supply voltage: 18 ... 30 V Current consumption, max.: 300 mA Interface: PROFIBUS DP, RS 232 Connections: 6 Piece(s) Degree of protection: IP 65
	50114154	MA 235i CANopen Gateway	Modular connection unit	Supply voltage: 18 ... 30 V Current consumption, max.: 300 mA Interface: CANopen, RS 232 Connections: 6 Piece(s) Degree of protection: IP 65
	50114155	MA 238i EtherCAT Gateway	Modular connection unit	Supply voltage: 18 ... 30 V Current consumption, max.: 300 mA Interface: EtherCAT, RS 232 Connections: 6 Piece(s) Degree of protection: IP 65
	50112891	MA 248i Profinet Gateway	Modular connection unit	Supply voltage: 18 ... 30 V Current consumption, max.: 300 mA Interface: PROFINET, RS 232 Connections: 6 Piece(s) Degree of protection: IP 65
	50114156	MA 255i DeviceNet Gateway	Modular connection unit	Supply voltage: 18 ... 30 V Current consumption, max.: 300 mA Interface: RS 232, DeviceNet Connections: 6 Piece(s) Degree of protection: IP 67
	50114157	MA 258i EtherNet/IP Gateway	Modular connection unit	Supply voltage: 18 ... 30 V Current consumption, max.: 300 mA Interface: EtherNet IP, RS 232 Connections: 6 Piece(s) Degree of protection: IP 65

Connection technology - Connection cables

	Part no.	Designation	Article	Description
	50130281	KD S-M12-CA-P1-020	Connection cable	Connection 1: Connector, M12, Axial, Female, A-coded, 12 -pin Connection 2: Open end Shielded: Yes Cable length: 2,000 mm Sheathing material: PUR

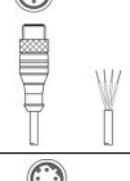
Part no.: 50128786 – DCR 202i FIX-M1-102-R3-G – Stationary 2D-code reader

	Part no.	Designation	Article	Description
	50130282	KD S-M12-CA-P1-050	Connection cable	Connection 1: Connector, M12, Axial, Female, A-coded, 12 -pin Connection 2: Open end Shielded: Yes Cable length: 5,000 mm Sheathing material: PUR
	50130283	KD S-M12-CA-P1-100	Connection cable	Connection 1: Connector, M12, Axial, Female, A-coded, 12 -pin Connection 2: Open end Shielded: Yes Cable length: 10,000 mm Sheathing material: PUR
	50134943	KD S-M12-CW-P1-050	Connection cable	Connection 1: Connector, M12, Angled, Female, A-coded, 12 -pin Connection 2: Open end Shielded: Yes Cable length: 5,000 mm Sheathing material: PUR
	50135073	KS ET-M12-4A-P7-020	Connection cable	Suitable for interface: Ethernet Connection 1: Connector, M12, Axial, Male, D-coded, 4 -pin Connection 2: Open end Shielded: Yes Cable length: 2,000 mm Sheathing material: PUR
	50135074	KS ET-M12-4A-P7-050	Connection cable	Suitable for interface: Ethernet Connection 1: Connector, M12, Axial, Male, D-coded, 4 -pin Connection 2: Open end Shielded: Yes Cable length: 5,000 mm Sheathing material: PUR
	50135075	KS ET-M12-4A-P7-100	Connection cable	Suitable for interface: Ethernet Connection 1: Connector, M12, Axial, Male, D-coded, 4 -pin Connection 2: Open end Shielded: Yes Cable length: 10,000 mm Sheathing material: PUR
	50135076	KS ET-M12-4A-P7-150	Connection cable	Suitable for interface: Ethernet Connection 1: Connector, M12, Axial, Male, D-coded, 4 -pin Connection 2: Open end Shielded: Yes Cable length: 15,000 mm Sheathing material: PUR
	50135077	KS ET-M12-4A-P7-300	Connection cable	Suitable for interface: Ethernet Connection 1: Connector, M12, Axial, Male, D-coded, 4 -pin Connection 2: Open end Shielded: Yes Cable length: 30,000 mm Sheathing material: PUR
	50134942	KS ET-M12-4W-P7-050	Connection cable	Suitable for interface: Ethernet Connection 1: Connector, M12, Angled, Male, D-coded, 4 -pin Connection 2: Open end Shielded: Yes Cable length: 5,000 mm Sheathing material: PUR



Connection technology - Interconnection cables

	Part no.	Designation	Article	Description
	50106905	KB ET-30000-SSA	Interconnection cable	Suitable for interface: Ethernet Connection 1: Connector, M12, Axial, Male, D-coded, 4 -pin Connection 2: Connector, M12, Axial, Male, D-coded, 4 -pin Shielded: Yes Cable length: 30,000 mm Sheathing material: PUR
	50132488	KB JST- M12A-12P-50	Interconnection cable	
	50137694	KDS S-M12-CA- M12-5A- P1-004-23X	Interconnection cable	Connection 1: Connector, M12, Axial, Female, A-coded, 12 -pin Connection 2: Connector, M12, Axial, Male, A-coded, 5 -pin Shielded: Yes Cable, crossed: Connection 1, pin 2 <-> connection 2, pin 3 Cable length: 400 mm Sheathing material: PUR
	50130284	KDS S-M12-CA- M12-CA-P1-020	Interconnection cable	Connection 1: Connector, M12, Axial, Female, A-coded, 12 -pin Connection 2: Connector, M12, Axial, Male, A-coded, 12 -pin Shielded: Yes Cable length: 2,000 mm Sheathing material: PUR
	50130285	KDS S-M12-CA- M12-CA-P1-050	Interconnection cable	Connection 1: Connector, M12, Axial, Female, A-coded, 12 -pin Connection 2: Connector, M12, Axial, Male, A-coded, 12 -pin Shielded: Yes Cable length: 5,000 mm Sheathing material: PUR
	50130286	KDS S-M12-CA- M12-CA-P1-100	Interconnection cable	Connection 1: Connector, M12, Axial, Female, A-coded, 12 -pin Connection 2: Connector, M12, Axial, Male, A-coded, 12 -pin Shielded: Yes Cable length: 10,000 mm Sheathing material: PUR
	50137077	KSS ET-M12-4A- M12-4A-P7-020	Interconnection cable	Suitable for interface: Ethernet Connection 1: Connector, M12, Axial, Male, D-coded, 4 -pin Connection 2: Connector, M12, Axial, Male, D-coded, 4 -pin Shielded: Yes Cable length: 1,000 mm Sheathing material: PUR
	50137078	KSS ET-M12-4A- M12-4A-P7-050	Interconnection cable	Suitable for interface: Ethernet Connection 1: Connector, M12, Axial, Male, D-coded, 4 -pin Connection 2: Connector, M12, Axial, Male, D-coded, 4 -pin Shielded: Yes Cable length: 1,000 mm Sheathing material: PUR
	50137079	KSS ET-M12-4A- M12-4A-P7-100	Interconnection cable	Suitable for interface: Ethernet Connection 1: Connector, M12, Axial, Male, D-coded, 4 -pin Connection 2: Connector, M12, Axial, Male, D-coded, 4 -pin Shielded: Yes Cable length: 10,000 mm Sheathing material: PUR
	50137080	KSS ET-M12-4A- M12-4A-P7-150	Interconnection cable	Suitable for interface: Ethernet Connection 1: Connector, M12, Axial, Male, D-coded, 4 -pin Connection 2: Connector, M12, Axial, Male, D-coded, 4 -pin Shielded: Yes Cable length: 15,000 mm Sheathing material: PUR

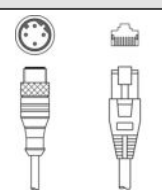
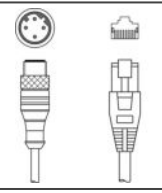
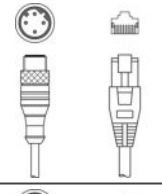
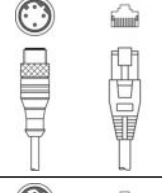
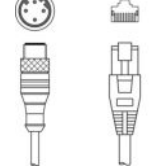
Part no.: 50128786 – DCR 202i FIX-M1-102-R3-G – Stationary 2D-code reader

	Part no.	Designation	Article	Description
	50135080	KSS ET-M12-4A-RJ45-A-P7-020	Interconnection cable	Suitable for interface: Ethernet Connection 1: Connector, M12, Axial, Male, D-coded, 4 -pin Connection 2: RJ45 Shielded: Yes Cable, crossed: Connection 1, pin 2 <-> connection 2, pin 3 Cable length: 2,000 mm Sheathing material: PUR
	50135081	KSS ET-M12-4A-RJ45-A-P7-050	Interconnection cable	Suitable for interface: Ethernet Connection 1: Connector, M12, Axial, Male, D-coded, 4 -pin Connection 2: RJ45 Shielded: Yes Cable, crossed: Connection 1, pin 2 <-> connection 2, pin 3 Cable length: 5,000 mm Sheathing material: PUR
	50135082	KSS ET-M12-4A-RJ45-A-P7-100	Interconnection cable	Suitable for interface: Ethernet Connection 1: Connector, M12, Axial, Male, D-coded, 4 -pin Connection 2: RJ45 Shielded: Yes Cable, crossed: Connection 1, pin 2 <-> connection 2, pin 3 Cable length: 10,000 mm Sheathing material: PUR
	50135083	KSS ET-M12-4A-RJ45-A-P7-150	Interconnection cable	Suitable for interface: Ethernet Connection 1: Connector, M12, Axial, Male, D-coded, 4 -pin Connection 2: RJ45 Shielded: Yes Cable, crossed: Connection 1, pin 2 <-> connection 2, pin 3 Cable length: 15,000 mm Sheathing material: PUR
	50135084	KSS ET-M12-4A-RJ45-A-P7-300	Interconnection cable	Suitable for interface: Ethernet Connection 1: Connector, M12, Axial, Male, D-coded, 4 -pin Connection 2: RJ45 Shielded: Yes Cable, crossed: Connection 1, pin 2 <-> connection 2, pin 3 Cable length: 30,000 mm Sheathing material: PUR

Connection technology - Connectors

	Part no.	Designation	Article	Description
	50132254	D M12A-12P	Connector	Connection: Connector with solder connection, M12, Axial, Female, A-coded, 12 -pin
	50112155	S-M12A-ET	Connector	Suitable for interface: Ethernet Connection: Connector, M12, Axial, Male, D-coded, 4 -pin

Connection technology - Adapters



	Part no.	Designation	Article	Description
	50132255	D M12A-12P-PWR	Adapter	Number of connections: 2 Piece(s) Connection 1: Connector, M12, Axial, Female, A-coded, 12 -pin Connection 2: Jack socket

Part no.: 50128786 – DCR 202i FIX-M1-102-R3-G – Stationary 2D-code reader





Mounting technology - Mounting brackets

	Part no.	Designation	Article	Description
	50132151	BT 320M	Mounting bracket	Design of mounting device: Angle, L-shape Mounting bracket, at system: Through-hole mounting Mounting bracket, at device: Screw type Type of mounting device: Rigid Material: Metal

Mounting technology - Rod mounts

	Part no.	Designation	Article	Description
	50132150	BTU 320M-D12	Mounting system	Contains: 4x M4 x 6 screws Design of mounting device: Mounting system Mounting bracket, at system: For 12 mm rod Mounting bracket, at device: Screw type Type of mounting device: Clampable, Adjustable, Turning, 360° Material: Metal
	50132453	BTU 320M-D12-RL70	Mounting system	Contains: 4x M4 x 6 screws Design of mounting device: Mounting system Mounting bracket, at system: For 12 mm rod Mounting bracket, at device: Screw type Type of mounting device: Turning, 360°, Adjustable, Clampable Material: Metal

General

	Part no.	Designation	Article	Description
	50132562	AC-RL-70/40-Diff	Vision component	
	50131462	Cover DCR 200i	Cover hood	Housing material: Plastic Optics cover: Plastic
	50131461	Cover DCR 200i-G	Cover hood	Housing material: Plastic Optics cover: Glass
	50131460	Cover DCR 200i-P	Cover hood	Housing material: Plastic Optics cover: Glass with polarization filter
	50131459	Diffusor DCR 200i	Film	
	50132511	RL-70/40r-003-M12	Illumination	

Notes

Observe intended use!

- This product is not a safety sensor and is not intended as personnel protection.
- The product may only be put into operation by competent persons.
- Only use the product in accordance with its intended use.